

LIVING & CO[®]

Washing Machine MODEL MFC90 9kg FRONT LOADER

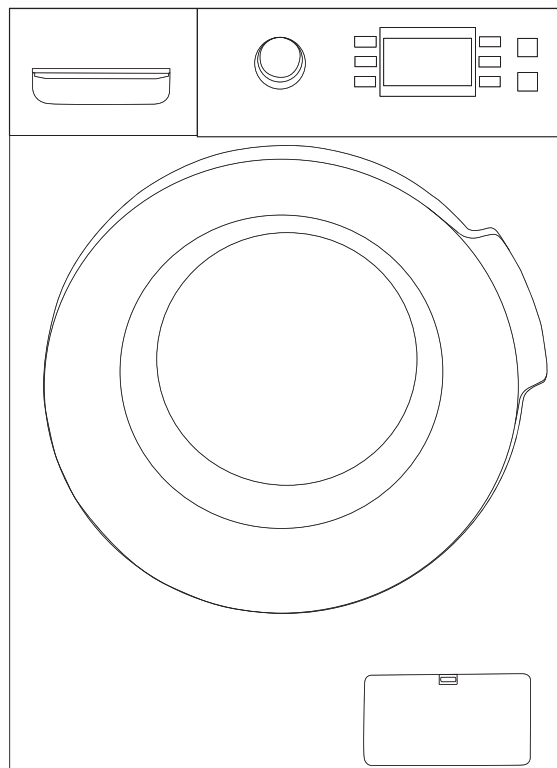

User Manual

AFTER SALES SUPPORT
☎ NZ 0800 422 274

TABLE OF CONTENTS

1. Safety Precautions	3
2. Washing Machine Overview	6
3. Installing the Washing Machine	7
4. Operating the Washing Machine	11
5. Maintenance	21
6. Troubleshooting	24
7. Error code display	25
8. Appendix	26

1. Safety Precautions

1.1 Safety Precautions

- If the supply cord is damaged, it must be replaced by the manufacturer, a service agent, or similarly qualified persons.
- Please use the new hose-sets supplied with the appliance. Old hose-sets should not be reused.
- This appliance is for indoor use only.
- Appliance openings must not be obstructed by carpet or other blockages.
- This appliance is not intended for use by persons (including children) with reduced physical, sensory or mental capabilities lack of experience and knowledge, , unless they have been given supervision or instruction concerning the use of the appliance by a person responsible for their safety. Children should be supervised to ensure that they do not play with the appliance.
- Disconnect the supply plug from the power socket before cleaning or maintenance.
- Make sure that all pockets are emptied before washing.
- **WARNING: Ensure the transport bolts (4) are removed from the appliance prior to operation. Failure to remove the transport bolts will cause permanent damage to the appliance and void its warranty.**
- Sharp and rigid items such as coins, brooches, nails, screws, stones, etc. may cause serious damage to this appliance.
- Disconnect the appliance's plug and turn off its water supply after operation.
- Check if water inside the drum has been drained before opening the door. Do not open the door if any water is visible.
- Pets and kids may climb into the machine. Check the machine before each use.
- Glass door may be very hot during operation. Keep kids and pets far away from the appliance during operation.

- Ensure that power, voltage, and frequency align with the appliance rating.
- Do not use any socket with a current rated less than that of the appliance. Never pull out the power plug with wet hands.
- To ensure your safety, the power cord plug must be inserted into an earthed three-pole socket. Carefully check and ensure that your socket is reliably earthed.
- Children under 3 years old should be kept away from the appliance unless continuously supervised.
- Children should be supervised to ensure that they do not play with the machine.
- Packing materials may be hazardous to children. Keep all packing materials (plastic bags, foam, etc.) far away from children.
- Do not installed the appliance in a bathroom, very wet rooms, or rooms with explosive or caustic gases.
- Make sure that the water and electrical supply are connected by a qualified technician in accordance with the manufacturer's instructions and local safety regulations.
- All packaging and transport bolts must be removed before operating this appliance. Failure to do so may seriously damage the appliance during wash cycles.
- Before washing clothes for the first time, run the appliance for one complete cycle while it is empty.
- Appliances with a single inlet valve can only be connected to cold water supply.
- The appliance for home use only and was designed for textiles suitable for machine washing.
- Do not wash with flammable, explosive, or toxic solvents are to be avoided. Do not use gasoline, alcohol, etc. as detergents. Only use detergents suitable for front load washing appliances.
- It is not recommended to wash carpets with the appliance.
- Avoid water discharge when the appliance is draining hot washing water.
- Never refill water by hand during a wash.

- Wait for two minutes after a program completes before opening the door.
- Remember to disconnect the water and power supply immediately after clothes are washed.
- Do not climb up and sit on top of the appliance cover.
- Do not lean against the appliance door.
- Do not close the door with excessive force. If you find it difficult to close the door, check that the drum is not overloaded with excessive clothing. If the drum is not overloaded, distribute clothing evenly and ensure the door opening is not jammed.
- Household washing appliances are not intended to be built-in.
- **Caution when relocating the machine**
 1. Transport bolts must be reinstalled by qualified service personnel.
 2. Drain accumulated water out of the appliance.
 3. Handle the appliance with care. Support the outer frame of the machine while lifting. Never use the door as a handle during transportation.

Notes on disposal:



This marking indicates that this product should not be disposed of with other household waste. To prevent possible harm to the environment or human health from uncontrolled waste disposal, recycle this appliance responsibly to promote the sustainable reuse of material resources. To return your used appliance, please use the collection systems or contact the retailer where the product was purchased.

2. Washing Machine Overview

2.1 Components

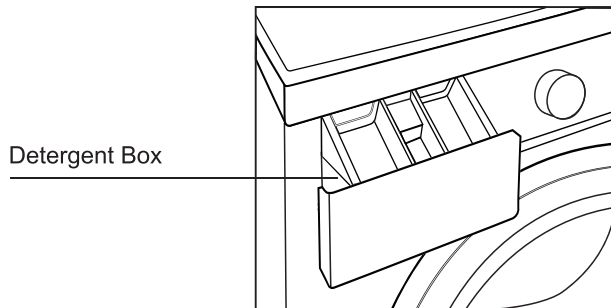
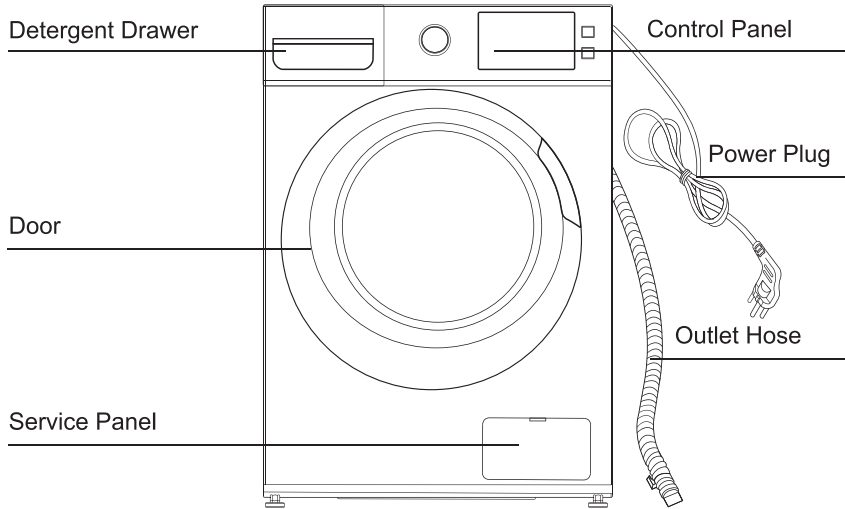

2.2 Accessories

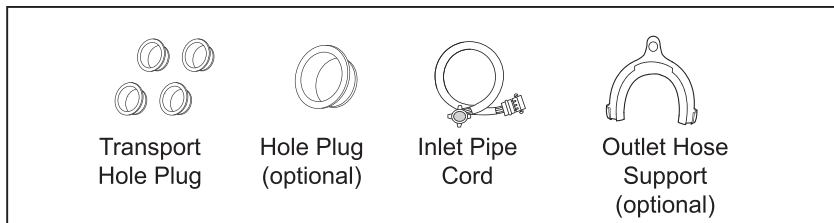

3. Installing the Washing Machine

3.1 Unpacking the Washing Machine

Unpack the appliance and check if it received any damage during transportation. Ensure that all the items in the attached bag were delivered.

If the appliance received any damage during transportation or any item is missing, please contact the supplier immediately.

3.2 Dispose of the Packing Materials

The appliance's packing materials may be hazardous to children. Dispose of them properly and prevent access to children. Dispose of the relevant packing materials according to relevant local regulations.

3.3 **WARNING:** Remove the Transport Bolts

Before using this appliance, remove the transport bolts located on the backside. Follow these steps to remove the bolts:

1. Loosen all bolts with a spanner, then remove them.
2. Stop the holes with transport hole plugs.
3. Keep the transport bolts in a safe location for future use.

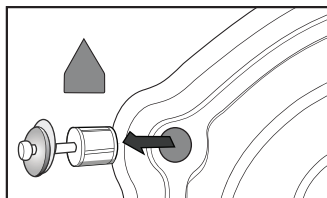

3.4 Select a Location

Before installing the appliance, select a location that matches the following criteria:

- Rigid, dry, and level surface (if the surface is not level, make it so by referencing the "Adjustment of Support Legs" refer section 3.5)
- Not exposed to direct sunlight
- Has sufficient ventilation
- Has a room temperature above 0°C
- Far away from heat sources such as coal or gas.

Ensure that the appliance is not placed on the power cord.

Do not install the appliance on carpeted floor.

3.5 Adjustment of Support Legs

1. When positioning the appliance, first check if its legs are closely attached to the cabinet. If they are not, turn them to their original positions by hand or with spanner, then tighten the nuts with a spanner.
2. After positioning the appliance, press onto the top cover corners in sequence. If the appliance seems unstable when being pressed, the leg must be adjusted.

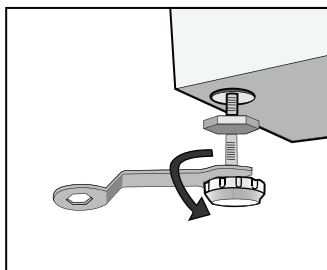

3. Ensure the stability of the appliance location. Loosen the lock nut with a spanner and turn the leg by hand until it is close contact with the floor. Press onto the leg with one hand and fasten the nut closely to the cabinet with the other.
4. After securing the corners, press onto them again to ensure that the adjustment is stable. If it is still unstable, repeat steps 2 and 3.
5. If you do not have a spirit level, then place a solid cylinder (e.g. a cylindrical can) opposite the top cover of the washing machine to check the level. The direction the cylinder rolls indicates where the appliance is lower relative to the ground surface. The legs in this direction should be raised until the appliance is level. Repeat steps 1-3 until the bottom legs are in firm contact with the ground and the nuts are locked tightly.

3.6 Connect the Water Inlet Pipe

Connect the inlet pipe as indicated in the figure.

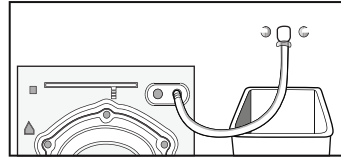

3.7 Install the Water Inlet Pipe

1. Connect the elbow to the tap and fasten it clockwise.
2. Connect the other end of the inlet pipe to the inlet valve at the backside of the appliance, then tightly fasten the pipe clockwise.

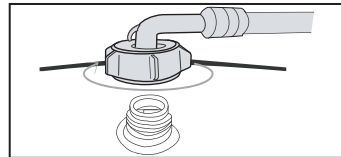

Note! If there is any hose leakage after connection, repeat the steps to connect the inlet pipe. Use the most common available tap to supply water. If tap is square or too big, switch to a standardized tap.

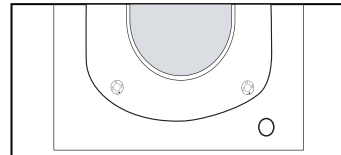

3.8 Hole Plug

The hole plug is used to fill the hole on the back cabinet.

3.9 Outlet Hose Placement

There are two placement options for the outlet hose end;

1. Positioned beside the sink/water trough.
2. Connected to the branch drain pipe in the sink/trough.

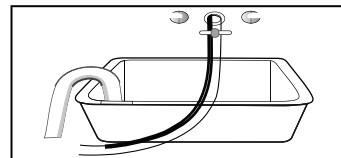

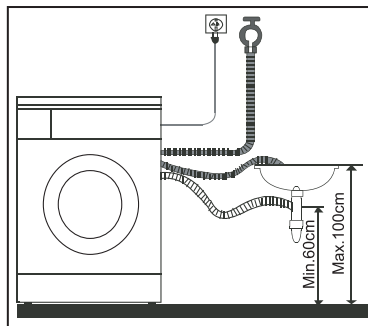
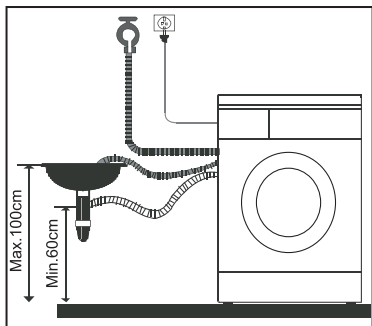

- The outlet hose should not be installed at a height beyond 100cm and its end should not be immersed in water.

Position the outlet hose securely to ensure the floor will not be damaged by water leakage.

Note! If the appliance supports an outlet hose, install it according to the following figures.

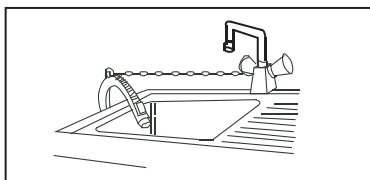

- Fix the outlet hose securely during installation using a rope or string.
- Position the outlet hose securely to ensure the floor will not be damaged by water leakage.

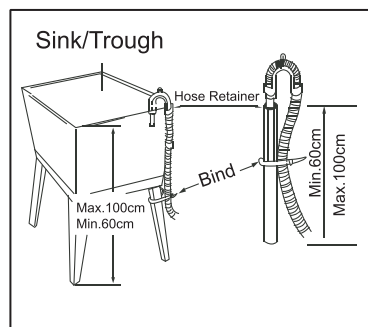

- If the outlet hose is too long, do not force it into the appliance, as this will cause abnormal noises.

3.10 Electrical Connection

- As the appliance's maximum current is 10A during heating, ensure your power supply system (current, power voltage, and wire) is capable of meeting normal the appliance's normal load requirements.
- Please connect the power to a correctly installed and properly earthed socket.
- Ensure the supply voltage is compatible with the markings on the appliance's rating label.
- The power plug must match the socket and cabinet must be properly and effectively earthed.
- Do not use multi-purpose plugs or sockets as an extension cord.

- Do not connect and pull out the plug with wet hands.
- Grip the plug tightly when connecting and pulling it out the. Do not pull the power cord forcibly.
- If the power cord is damaged or shows any sign of being broken, seek repairs from an authorised service agent.

- Warning!**
- 1. The appliance must be earthed properly.** If there are any short circuits, earthing can reduce the danger of electrical shock.
The appliance is equipped with a power cord, which includes a plug, earthing wire, and earthing terminal.
 2. The appliance must be operated in a circuit separate from other electrical appliances. Sharing circuits with other appliances may trigger household circuit protection.

4. Operating the Washing Machine

4.1 Pre-Wash Checklist and Preparation

Read carefully to avoid issues with the appliance and damage to clothes.

Do not mix coloured clothing with bleached/white clothing:

Colours can run when washed (particularly when placed in warm/hot water). Some coloured items (especially new ones) are best washed separately or with similar coloured items.

To remove stains on sleeves, collars, and pockets, use liquid detergent and scrub gently with a brush, then place in the washing machine for best results.

Wash temperature-sensitive clothes according to label instructions. Failure to follow instructions may cause colour change or distortion.

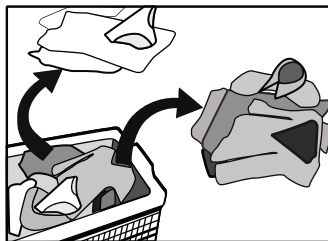

Keep in Mind:

Never leave clothes in the appliance for extended periods of time, as this may cause mould and staining.

Ventilate clothes in air/dry as soon as possible. Coloured clothing may fade or distort if not washed according to the stated washing temperature.

Clothes Cannot be Washed in a Washing Machine

Some clothes may get distorted if immersed in water:

Ties, waistcoats, suits, outer garments, etc. may shrink if immersed in water.

Wrinkled clothes, embossed clothes, resin clothes, etc. may distort if immersed in water.

Wrinkled silk, fur products, and fur accessories may distort;

Accessorized clothes, long dresses, and traditional clothes, etc. may be damaged easily.

Do not wash clothes without first reading material labels and washing requirements.

Never wash clothes stained with chemicals such as gasoline, petroleum, benzene, paint thinner, and alcohol.

Note on Detergent Types

"Low bubble" detergents, washing powders, or drum wash powders should be selected according to fibre type (cotton, synthetic fibre, soft products, and wool products), colours, washing temperatures, dirtiness, and clothing type. Failure to select the proper detergent may cause excessive bubbling and drawer overflow.

As bleach can damage clothing, it is suggested to use as little as possible.

Make sure to sufficient rinse clothing, as powder detergents can easily leave residue.

Some powder detergents may not fully dissolve if there is too much detergent or the water temperature is too low. This can result in residue remaining on clothes and parts of the appliance.

The wash program should be selected according to clothing weight, dirtiness, local water hardness, and recommendations from detergent manufacturers. Please consult your utilities provider if you are unsure of your local water hardness.

Note! Keep detergents and additives in a safe and dry place out of the reach of children.

Remove All Items From Pockets

Check the pockets of clothing to be washed and empty solid items such as keys and coins to avoid permanent damage to the appliance.

Size: wash clothing of different sizes together to improve wash efficiency. Sensitivity:

soft items should be washed separately. Use the soft was program for new pure wool textiles, curtains, and silks.

Check the labels of all items before washing.

Clothes should be sorted before they are placed in the appliance. Remove any hooks from curtains before they are washed.

Clothing accessories may damage the appliance. Turn clothing with buttons or embroidery inside out before washing.

Secure Fasteners:

Ensure zips are properly zipped closed and buttons or hooks are fixed. Bind loose cords or ribbons together.

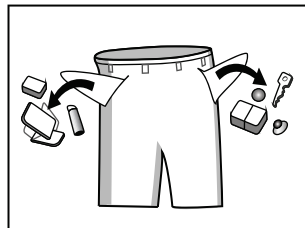

Warning!

It is suggested to put bras into a zip or button sealed pillowslip to prevent the steel wire from popping out into the drum and damaging the appliance.

Delicate textiles such as laced curtains, suit jackets, small items (tight socks, handkerchiefs, ties, etc.) should be placed into a string bag for washing.

Washing a single large item (such as a large jacket) may cause load imbalance. It is recommended to add several items of clothing to be washed together to ensure draining is done smoothly.

Brush Pet Hair Off Clothing

Clothing may be damaged by additional friction between hair and the material.

/Protecting Baby Skin

Baby clothing, towels, and napkins should be washed separately. Rinse times should be increased to ensure thorough rinsing and cleaning of detergent residue.

It is suggested that easily stained items such as white socks, collars, sleeves, etc. are hand washed before being placed in the appliance for better results.

Use powder or liquid detergents. Soap residue could remain in clothing gaps if used.

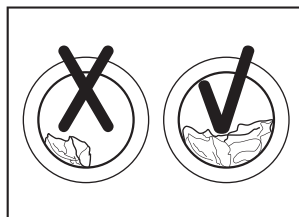
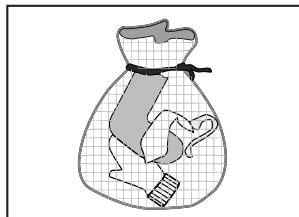

Confirming Wash Capacity:

To ensure best results, do not place excessive amounts of clothing in the appliance. Follow the maximum suggested wash quantity according to the following table:

Fibre Type	Maximum Load Capacity
	9.0kg
Cotton	9.0kg
Synthetic	4.5kg
Wool	2.0kg
Delicate	2.5kg

Easily Fuzzed Clothing Should be Turned Over for Washing

Clothing that is easily fuzzed should be washed separately to prevent other items from being stained with dust, thrum, etc. Ideally, black and cotton clothes should be washed separately as they are easily stained with the thrums of other colours when washed together.

Do not use the Appliance to Wash Waterproof items (e.g. ski suits, plastic raincoats, or car covers)

Washing fibre products that cannot be easily soaked such as waterproof cushions and clothes is not recommended as this may damage the washed items.

4.2 Quick Start

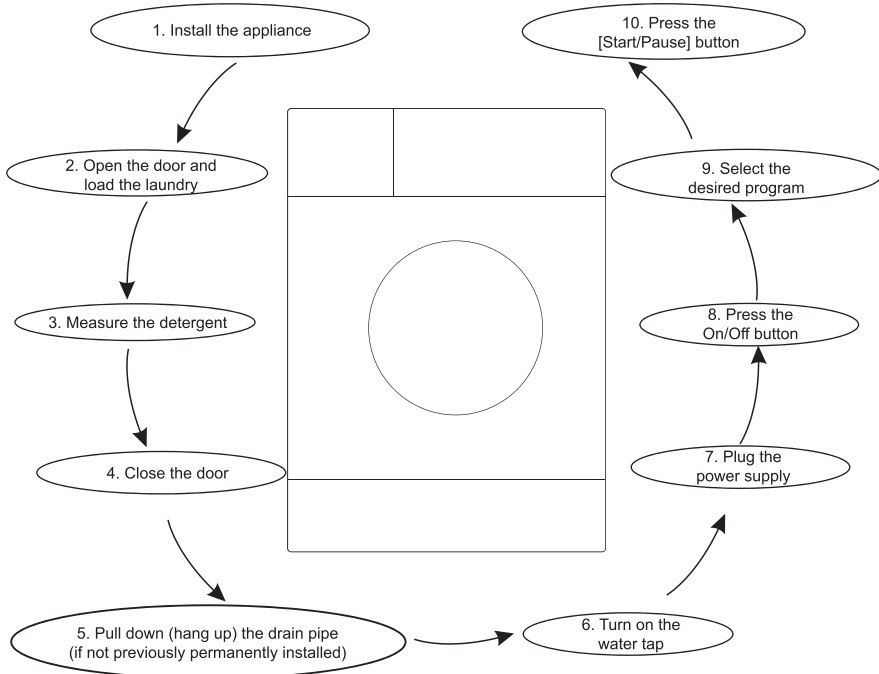

After washing is completed:

1. The appliance will make a beeping sound
2. Close the water tap
3. Press the On/Off button and pull out the power plug.

4.3 Control Panel View

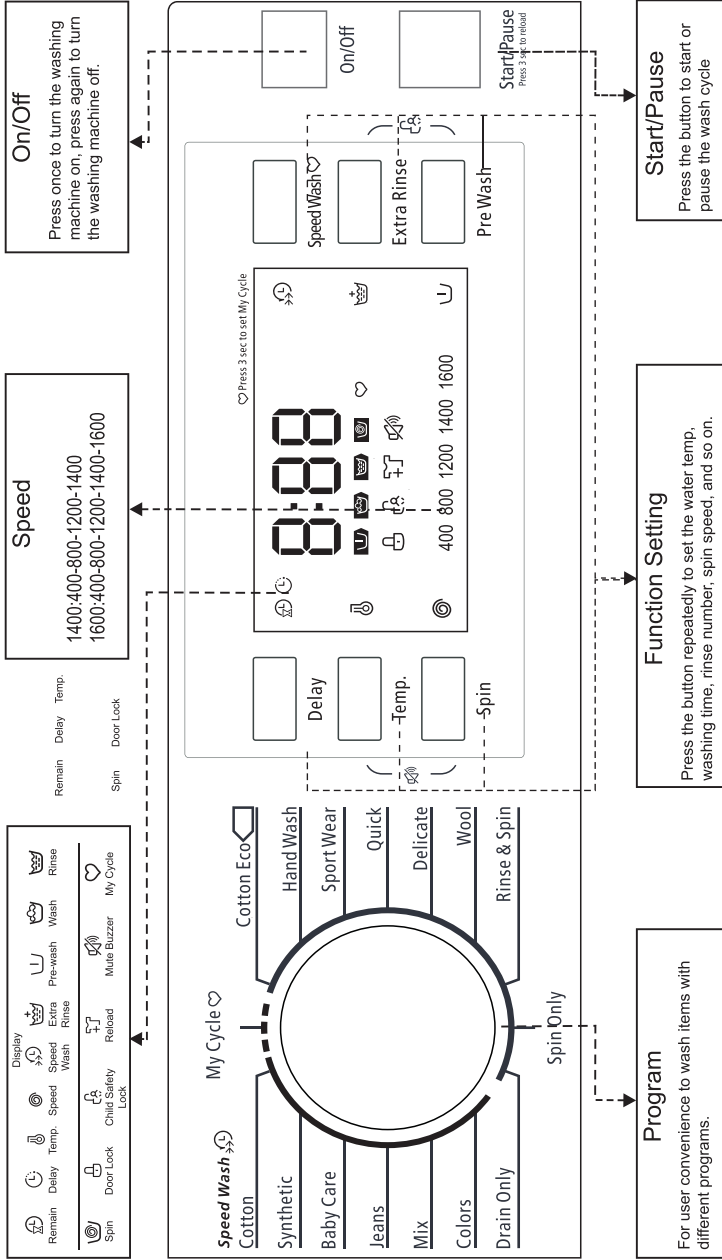

4.4 First-Time Wash

Before washing for the first time, run the appliance for one complete cycle while empty according to the following instructions:

1. Connect the appliance to a water and power source.
2. Put a little detergent into the box and close it.
3. Press the “On/Off” button.
4. Press the “Start/Pause” button.

The drawer is separated as follows:

I: Pre-detergent or washing powder.

II: Primary detergent

☼: Washing additive such as fabric softener or tackifier.

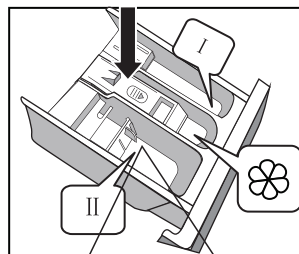

4.5 Put Detergent in the Appliance

1. Pull out the drawer.
2. Fill pre-detergent in case I (when necessary).
3. Fill detergent in case II.

Option1: detergent (powder). Option2 (liquid)

4. Fill softener in case ☼ (when necessary).

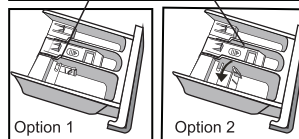

- Note!** - If the washing powder has caked together or has solidified, it is suggested to use some water to dilute the powder to prevent the detergent box inlet from being blocked or overflowing with water.
- Choose suitable detergents for the various washing temperatures to get the best washing performance with less water and energy consumption.

4.6 Start the Appliance

Connect the power and check if the water pipes are connected properly. Open the tap completely, put the clothes to be washed in and fill with the detergent. Next, press the “On/Off” button, select the proper procedures and functions, then press the “Start/Pause” button.

4.7 Select the Program

Select a proper washing program according to the type, quantity, and dirtiness of the items to be washed by referencing the following wash temperature table.

90 °C	Very dirty items and pure white cotton (for example: coffee table cloths, canteen table cloths, towels, and bed sheets)
60 °C	Moderately dirty items, cotton, and synthetic items with coloured printing (for example: shirts and pyjamas).
40 °C, 30 °C, 20 °C, cold water	Slightly dirty items (for example: synthetic and wool)

Turn the rotary switch to select the corresponding program according to the type of textile. Next, select the desired temperature according to the dirtiness. In general, the higher the temperature, the higher the power consumption. Finally, select the desired spin speed. The higher the spin speed is, the drier the textiles will be spun.

PLEASE NOTE: select a lower spin speed to protect delicate textiles.

The main wash programs depend on the types of items to wash are as follows:

- **Cotton**

Select this program to wash common use clothing. It is recommended to use this program for common use cotton items such as bed sheets, quilt covers, pillowcases, gowns, underwear, etc.

- **Cotton ECO**

Increase the main washing time to improve wash results.

Recommended for clothes worn by babies and people with sensitive skin.

- **Synthetic**

This program can be used to wash delicate clothes. The program is shorter compared to Cotton ECO and washing intensity is reduced. Recommended for synthetic items such as shirts, coats, and blending. The "Synthetic" program should be selected for curtains and laced textiles. Reduce the quantity of detergent while washing knitted textiles.

- **Baby Care**

Select this program to wash baby clothes. This program improves rinse and cleaning performance to better protect baby skin.

- **Jeans**

This program is specially designed for washing jeans.

- **Mix**

Select this program to wash more durable items that require longer cleaning times. This program can be used for daily use items and cotton, such as sheets, pillowcases, bathrobes, and underwear.

- **Colours**

This program can be used for washing brightly coloured clothing and reduces the possibility of fading.

- **Drain Only**

Separate drain only cycle.

- **Spin Only**

Separate spin only cycle. Soap or rinse water should be drained out before spinning.

- **Rinse & Spin**

Separate rinse and spin cycle.

- **Wool**

Select this program to wash wool textiles labelled with "Machine Wash". Select the proper wash temperature according to labels of the washed items. Ensure that a suitable detergent is selected for wool textiles.

- **Delicate**

Select this program to wash delicate items. This program has a gentler wash intensity and spin speed compared with the "Synthetic" program. It is recommended for items that should be washed softly.

- **Quick**

This program is suitable for washing a smaller quality of lightly dirtied items quickly.

- **Sportswear**

Select this program to wash sportswear.

- **Hand Wash**

This program is suitable for washing a smaller quality of lightly dirtied items with cold water.

- **My Cycle**

Press and hold Speed Wash for 3seconds and My Cycle will memorise your settings. The default cycle is cotton.

The main function can be selected as follows:

- **Pre-wash**

The Prewash function provides an extra wash before the main wash.

- **Speed Wash**

The function decreases the wash time.

- **Extra Rinse**

The laundry will undergo an extra rinse.

- **Delay**

This button enables the Delay function for up to 0-24h. To set the Delay function:

1. Select a program.
2. Press the Delay button to select the time.
3. Press Start/Pause to commence the delay operation.

To cancel the Delay function: press and hold the Delay button until the display shows 0h.

On/Off button

Note! If there is any break in the power supply while the appliance is running, the selected program is stored in memory and will resume when the Start/Pause button is pressed after power is restored.

- **Reload**

To manually add clothes to the appliance once the door is locked and an operation has commenced, follow these steps:

1. Press the "Start/Pause" button.
2. Wait until the drum stops rotating.
3. Wait several seconds for the door to unlock, then open the door.
4. Insert the additional items, close the door, and press the "Start/Pause" button again.

- **Child Safety Lock**

Use this feature to prevent misuse by children. Once selected, the only button that will remain operational is the On/Off button.

Note! The appliance will remain in child safety lock once power resumes after a power outage. Press and hold the Extra Rinse and Pre-Wash buttons for 3 seconds to engage the function. The buzzer will beep to signal that the child safety lock is enabled. To disable child safety lock, press and hold the Extra Rinse and Pre-Wash buttons for 3 seconds. The buzzer will beep to signal an unlock.

- **Muting the Buzzer**

To mute the buzzer, press and hold the “Temp & Spin” button for 3 seconds, you should hear a beep.

To restore the buzzer function, press and hold the “Temp & Spin” button again for 3 seconds. The setting will be maintained until the next reset.

Warning! By muting the buzzer function, you will have disabled the appliance's notification sounds.

4.8 Table of Washing Functions

Program Description	Load (kg)	Detergent Box			Delay	Speed Wash	Extra Rinse	Pre-wash	Default Temp. (°C)	Default Time	Default Speed (RPM)
		Case I	Case II	Softener Case							
Cotton	9.0	○	●	○	○	○	○	○	40	2:40	800
Synthetic	4.5	○	●	○	○	○	○	○	40	1:40	800
Baby Care	9.0	○	●	○	○	○	○	○	30	1:20	800
Jeans	9.0	○	●	○	○	○	○	○	60	1:45	800
Mix	9.0	○	●	○	○	○	○	○	40	1:13	800
Colours	4.5	○	●	○	○	○	○	○	Cold	1:10	1200
Drain Only	-	×	×	×	○	×	×	×	-	0:01	-
Spin Only	9.0	×	×	×	○	×	×	×	-	0:12	1200
Rinse & Spin	9.0	×	×	○	○	×	×	×	-	0:20	1200
Wool	2.0	×	●	○	○	×	×	×	40	1:07	800
Delicate	2.5	×	●	○	○	×	×	×	30	0:50	800
Quick	2.0	×	●	○	○	×	×	×	Cold	0:15	800
Sportswear	4.5	×	●	○	○	×	○	○	40	0:45	1200
Hand Wash	2.0	×	●	○	○	×	○	○	Cold	1:00	800
Cotton ECO	9.0	×	●	○	○	×	×	×	60	4:56	1600

Energy test program: Cotton ECO 60°C; Speed: highest; Other: default.

Full load:9.0kg; half load: 4.5kg.

"Cotton ECO 60°C " is the "standard Cotton 60/40°C" program and the standard washing program referenced by wash labels. It is suitable for cleaning normally dirtied cotton laundry and is the most efficient program in terms of combined energy and water consumption for cotton laundry. Actual water temperature may differ from specified cycle temperature.

● Required ○ Optional × Unnecessary

Note! The parameters on this table are for user reference only. Actual parameters maybe different from those on the above table.

5. Maintenance

Before maintenance, pull out the power plug and turn off the water supply tap.

- Warning!**
- Do not use solvents in order to prevent damage to the appliance and explosion hazards resulting from generation of toxic gases.
 - Never spray the enclosure of the appliance with water.
 - Do not use detergents containing PCMX to clean the appliance.

5.1 Cleaning and Maintenance of Appliance Cabinet

Proper maintenance of the appliance can extend its lifecycle. The surface can be cleaned with diluted non-abrasive neutral detergents when necessary. If there is any water overflow, use a wet cloth to wipe it up immediately. Avoid scraping the appliance's surface with sharp objects.

Note! Do not use formic acid, its diluted solvents, or any equivalent.

5.2 Cleaning the Internal Drum

Any rust left inside the drum by metal objects must be removed immediately with chlorine-free detergents.

Do not use steel wool.

5.3 Repairing a Frozen Appliance

If temperature drops below zero and part of the appliance becomes frozen, you should:

1. Disconnect the power supply for the appliance.
2. Wash the tap with warm water to loosen the inlet pipe.
3. Detach the inlet pipe and immerse it in warm water.
4. Pour warm water into washing drum and wait for 10 minutes.
5. Reconnect the inlet pipe to the tap and check whether the inlet and outlet are working normally.

Note! Ensure that the ambient temperature is above 0 °C before using the appliance again.

5.4 Freeze Prevention

If the appliance is located in a room where it can get frozen easily, drain the remaining water inside the drain pipe and inlet pipe thoroughly.

Removing Remaining Water From the Inlet Pipe:

1. Close the water supply tap.
2. Unscrew the inlet pipe from the tap and place its end into a container.

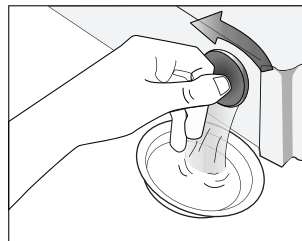

- Engage any function except single Wash or Drain. Water will be drained out of inlet pipe for about 40 seconds.
- Reconnect the inlet pipe to the tap.

Removing Remaining Water From the Drain Pump:

Warning! To avoid burn hazards, only remove remaining water after hot water inside the appliance cools down.

5.5 Cleaning the Detergent Box and Grooves

- Press down on the area indicated by the arrow location on softener cover inside the drawer.
- Lift the clip up, take out the softener cover, and wash all grooves with water.
- Place the softener cover back and push the drawer into position.

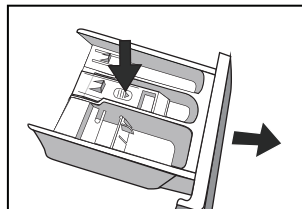

5.6 Cleaning the Inlet Filter

The inlet filter should be cleaned if there is insufficient water when the tap is opened.

Clean the tap filter:

- Close the tap.
- Engage any function except "Wash" or "Drain".
- Press the "Start/Pause" button and keep the procedure running for about 40 seconds.
- Remove the inlet pipe from the tap.
- Use water to wash the filter.
- Reconnect the inlet pipe.

Washing the filter in the washing machine:

- Screw off the inlet pipe from the backside of the machine.
- Pull out the filter with long nose pliers and reinstall it after washing.
- Reconnect the inlet pipe.
- Open the tap and make sure there is no water leakage.
- Close the tap.

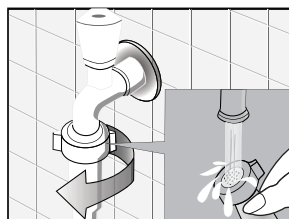
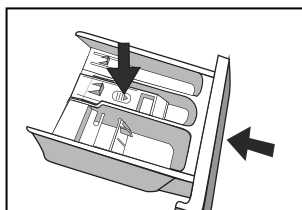
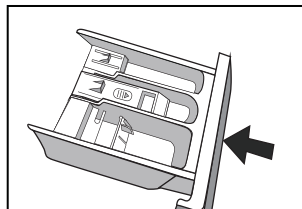

Note! Wash the tap filter first, then the appliance filter.
If only the appliance filter is washed, repeat tap filter cleaning steps 1-3.

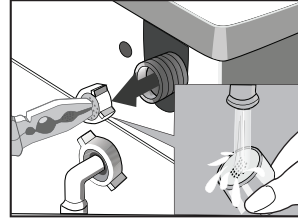
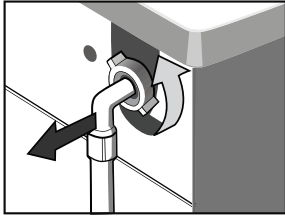

Warning!

Drain Pump Filter:

The drain pump filter may collect cotton and small external matter from washing water. Clean the filter periodically to ensure normal operation of the appliance.

Warning!

Inspect and clean the filter regularly, in accordance with cycle frequency and dirtiness. Inspect the pump filter if the machine does not empty and/or spin. The appliance will make abnormal noises during draining if objects such as safety pins, coins, etc. block the pump.

Removing external items from the pump:

1. After the power is disconnected, open the filter cover by hand.
2. Turn the filter down as shown on the figure and take out any external matter.
3. Reinstall each part after external matter is removed.

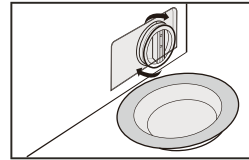
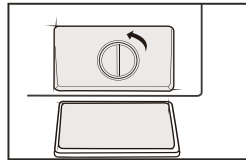
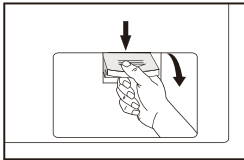

Warning!

There may be hot water in the pump while the appliance is in use, depending on the selected program. Never remove the pump cover during a wash cycle, always wait until the appliance has finished the cycle and is empty. Make sure that the cover is tightly secured during replacement.

6. Troubleshooting

Problem	Reason	Solution
The appliance will not start	The operation procedure has not been correctly followed	Check if the door was closed tightly. Check if power plug was inserted properly. Check if the water supply tap is open. Check if the "Start/Pause" button was pressed. Check if the "On/Off" button was pressed.
The door cannot be opened	The appliance's safety features have been engaged.	Disconnect the power.
Heating not working	The NTC is damaged and the heating pipe is aged.	Clothes can be washed normally, just without heating. Contact the service centre in a prompt manner.
Water leakage	The connection between the inlet pipe or outlet hose and the tap or appliance is not tight enough. The drain pipe is blocked.	Check and fasten the water pipes. Clean the outlet hose and ask a qualified specialist to repair it when necessary.
Water is overflowing from the bottom of the appliance	The inlet pipe is not connected firmly. The outlet hose is leaking water.	Fix the inlet pipe. Replace the drain hose.
The indicator or display does not light.	The power is disconnected.	Check if the power is on and if the power plug is connected correctly. If not, contact the service line.
Detergent residue found in the box	Washing powder became dampened and agglomerated.	Clean and wipe the box. Use liquid or front loader detergents.
Wash results were not satisfactory.	The clothes are too dirty. Not enough detergent was used.	Select a more suitable program. Use a more suitable detergent quantity according to the instructions on the detergent package.

Problem	Reason	Solution
Strange noises or excessive vibration	Setup procedures were not been followed correctly.	Check if the transportation fixing (bolts) have been removed. Check if the cabinet is installed on a solid and level floor. Check if there are any loose objects inside the drum. Check if the appliance's legs are level.

































7. Error code display

Display LED	Description	Reason	Solution
<i>E30</i>	Problem with door lock	The door was not closed properly.	Restart after the door is closed.
		Contact the service line if the problem persists.	
<i>E10</i>	Problem with water injection during wash	The tap was not opened or the water is flowing too slowly. The inlet valve filter is blocked. The inlet pipe is twisted. Water is not being supplied.	Open the tap or wait until water supply returns to normal. Check the inlet valve filter. Straighten the water pipe and check the other taps in the room.
		Contact the service line if the problem persists.	
<i>E21</i>	Problem with draining during wash	The outlet hose is blocked/twisted or the drain pump is blocked.	Wash and straighten the outlet hose. Wash the drain pump filter.
		Contact the service centre if a problem persists.	
Contact the service centre if any other problem is found.			

8. Appendix

8.1 Labels

The label and sign on the fabric can help you to select the best way to wash your clothes.

 Normal wash  Gentle wash	 Warm wash (max 40°C)	 Hand wash  Do not wash	 Bleach  Do not bleach	 Chlorine bleach may be used  Do not use chlorine bleach	 Medium tumble dry (max 150°C)  Low tumble dry (max 110°C)
 Iron  Do not iron	 Cool iron (max 110 °C)  Medium warm iron (max 150 °C)	 Dry clean  Do not dry clean	 Normal dry clean cycle with any solvent  Normal dry clean cycle with petroleum solvent only	 Normal tumble dry  Dry flat	 Drip dry  Hang/Line dry
 Iron with cloth  Steam Iron	 Dry after wash  Line dry in shade	 Warm dry clean  Do not tumble dry	 Line Dry	 Do not wring	 Do not machine wash

Electrical Warning

To avoid fire, electrical shock, and other hazards, keep the following in mind:

- Only the voltage indicated on the rating label should be used.
- When using the heating function, the maximum current through the appliance will reach 10A. Make sure the power supply units (current, voltage, and cable) can meet normal load requirements of the appliance.
- Protect the power cord properly. The power cord should be fixed properly to ensure it does not cause any tripping or damage hazards. Pay special attention to the socket and plug location, which should plug in easily.
- Do not overload a wall-mounted socket or overextend a cable. Overloading of wiring may cause fire or electrical shock. Do not pull out the power plug with wet hands.
- To ensure your safety, inserted the power plug into an earthed three-pole socket. Carefully check and ensure that the socket is properly and reliably earthed.

Specifications	
Washing Capacity	9.0kg
Dimensions (W* D* H) mm	595*565*850
Net Weight	72kg
Rated Power	1950W
Power Supply	220-240V~, 50Hz
Max Current	10A
Standard Water Pressure	0.05MPa~1MPa

8.2 COMPLIANCE

This product has been fully tested and meets all requirements as set out by standards AS/NZS 60335.1 and AS/NZS 60335.2.7.



The RCM Mark (Regulatory Compliance Mark) indicates that the product complies with the relevant guidelines of the ACMA as well as corresponding E2198 government requirements for the safety of electrical devices.

8.3 RESPONSIBLE DISPOSAL

At the end of its working life, do not throw this appliance out with your household rubbish. Electrical and electronic products contain substances that can have a detrimental effect on the environment and human health if disposed of inappropriately. Observe any local regulations regarding the disposal of electrical consumer goods. Dispose of the appliance appropriately for recycling. Contact your local authorities for information on recycling facilities in your area.



LIVING & CO[®]

Warranty

We pride ourselves on producing a range of quality products that are both packed with features and completely reliable. We are so confident in our products, we back them up with a two years warranty. Now you too can relax knowing that you are covered.

Customer Helpline NZ: 0800 422 274
This product is covered by two years warranty
when accompanied by proof of purchase.

AFTER SALES SUPPORT
  0800 422 274